

# **BASIC K10 system** installation guide for balconies, patios and terraces with resin flooring.

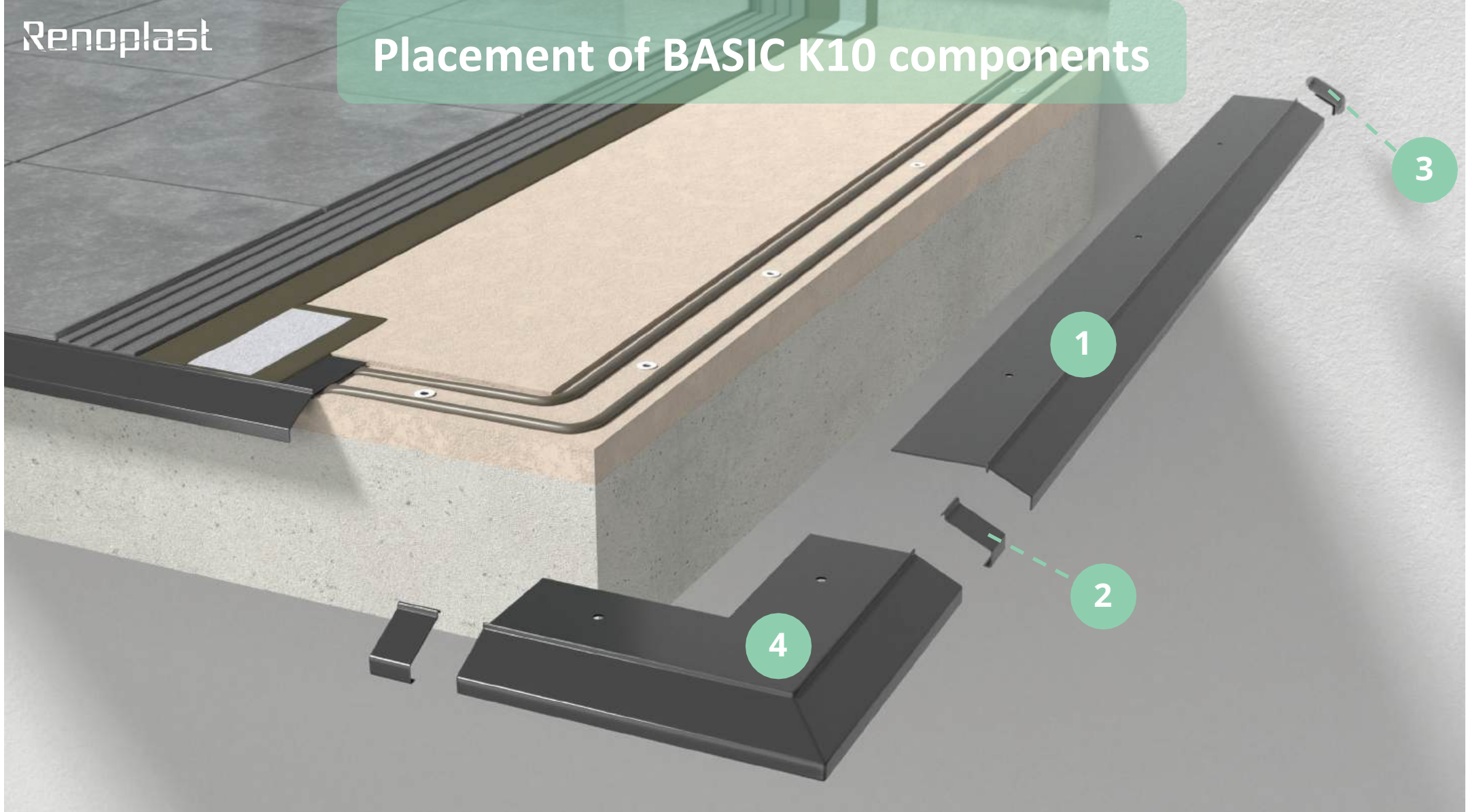

# Placement of BASIC K10 components



**K10 drip edge  
200 cm length**

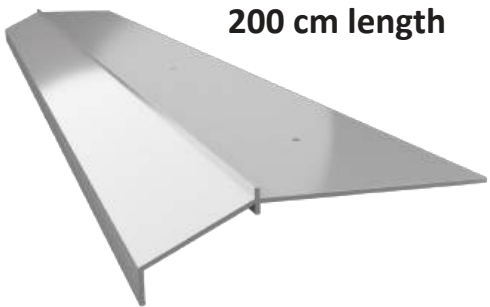

1

**LK10/LK100/LK10R/LK100R  
drip edge clip**



2

**OPK10/OPK100/OP10R/  
OP100R P+L  
wall protection end caps**



3

**K10 90 external  
corner**



4



## Balcony/ terrace floor screed

The floor screed should be structurally sound and even, sloping 1.5 – 2% towards the balcony/terrace front edge. Along the balcony/ terrace edge a 3 mm deep by 80 mm wide recess should be made in the screed to allow setting the drip edge flush with the screed top surface.



## Priming the screed

A suitable floor primer should be applied on the screed layer. The primer must be compatible with the chosen resin flooring system.



### **Pre-fitting K10 90 external corners**

Start the installation by pre-fitting the external corners using the supplied plastic wall plugs.



## Preparation of K10 drip edges

Measure straight lengths to cut the **K10** drip edges to the required length. Allow for ca. 2 mm wide expansion joints between adjacent drip edging sections. At walls leave sufficient space for fitting **OPK10/OPK10R/OPK100/OPK100R** wall protection end caps. For cutting use a metal handsaw or a circular saw equipped with an aluminium cutting disc. Other tools may damage the paint coat, which is considered unacceptable.

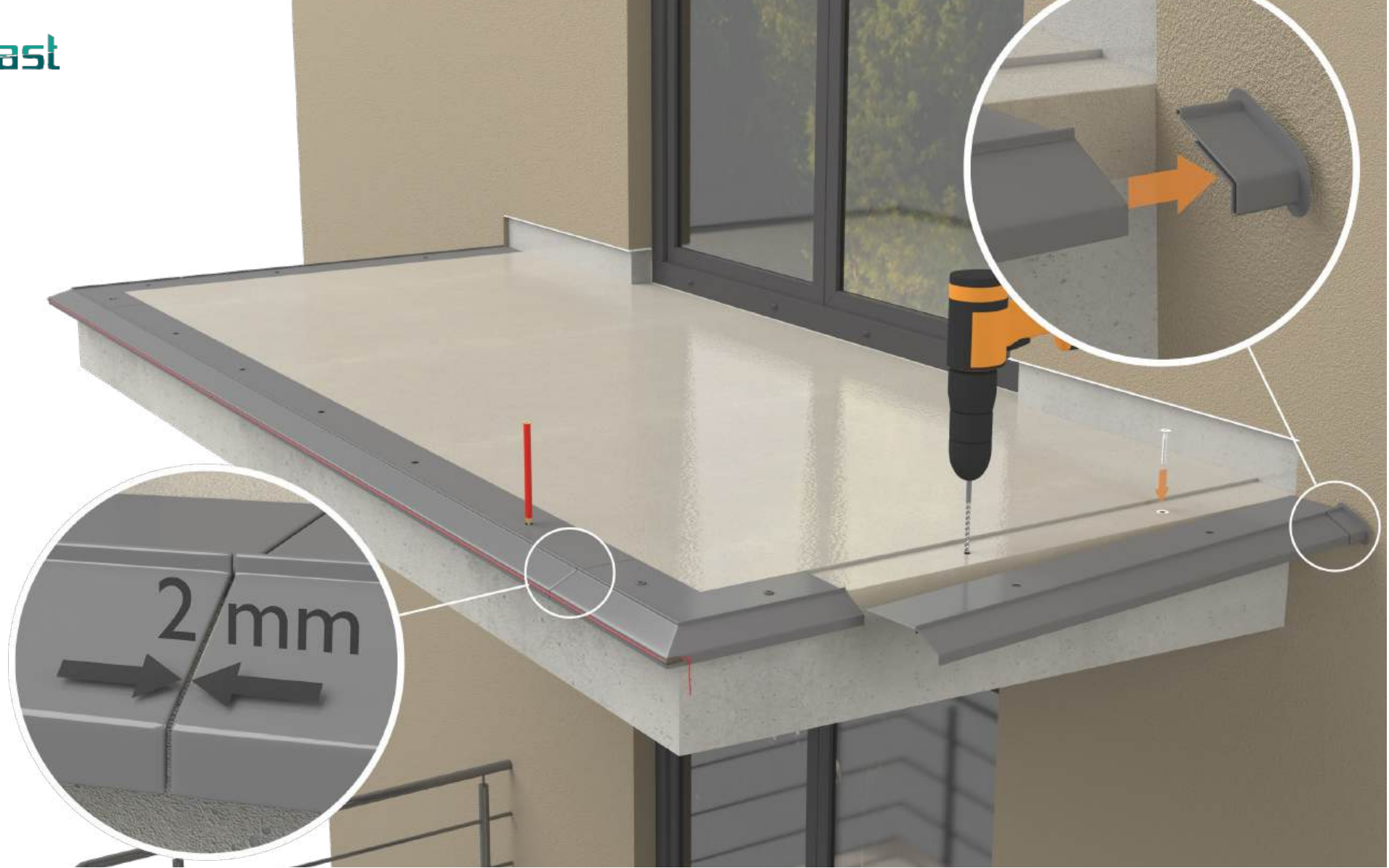

## Making fixing holes in the screed

Lay **K10 drip edges** between the pre-fitted **K10 90 external corners** and mark fixing holes positions. Remove the drip edging to drill the fixing holes in the screed.



## Final fixing of K10 90 external corners

External corners should be bedded on the applied sealing slurry and mechanically fixed using the pre-installed plastic plugs. Once the slurry has cured tighten the plug screws as required.



## Fixing of K10 drip edges

Straight sections are fitted in the same way as corner pieces. Use a string line stretched between adjacent corners and a spirit level to ensure straight and level alignment. Fill edging joints with a flexible (e.g., polyurethane) sealant and snap the **LK10/LK10R/LK100/LK100R** drip edge clip as shown.

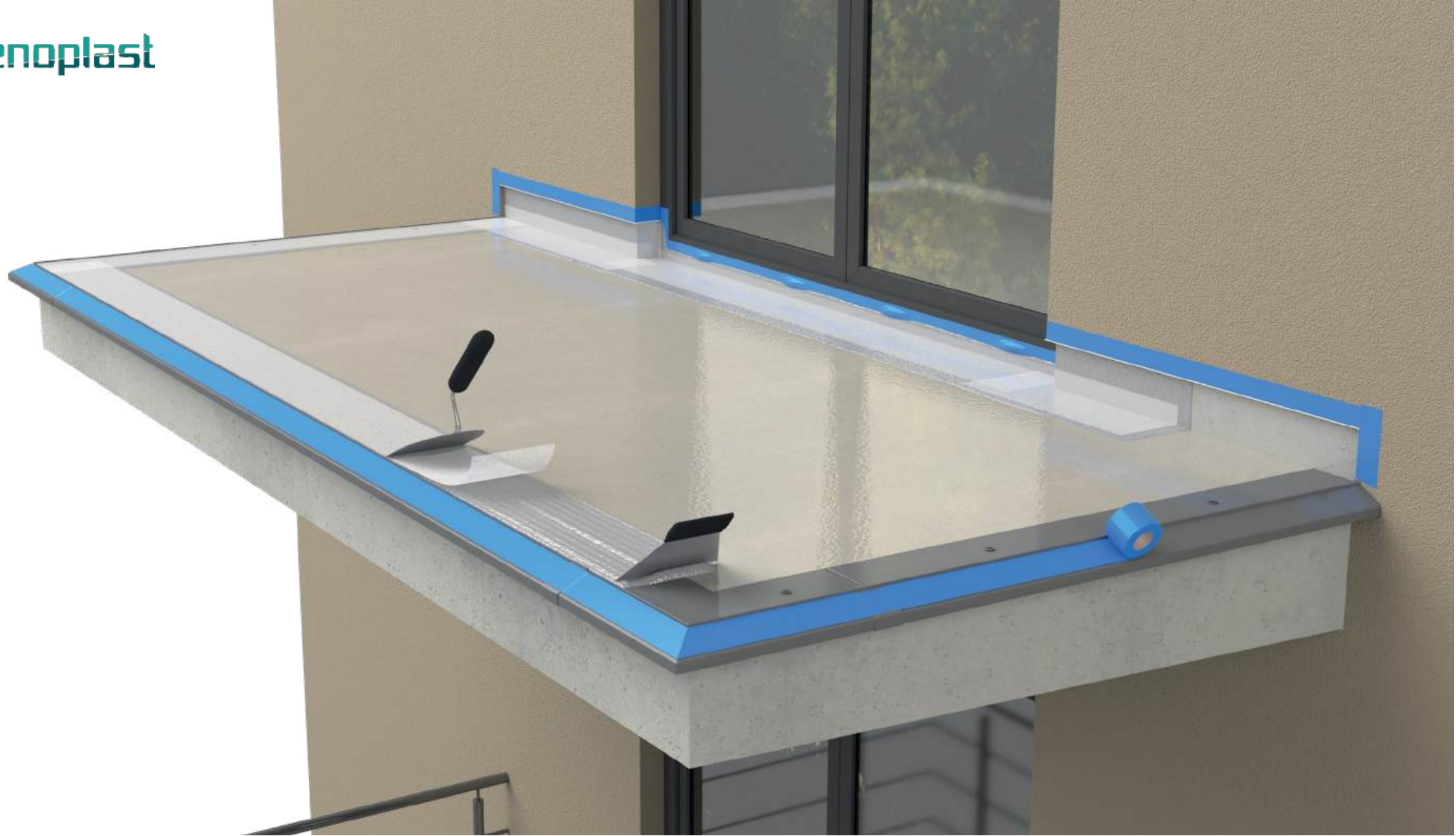

## **Bonding with the screed**

Drip edging is bonded to the screed by means of a layer of nonwoven fabric or mesh embedded in resin. Nonwoven fabric or mesh may be placed over drip edging joints only or all over the screed surface (follow resin manufacturer's recommendations).



### Waterproofing resin application

Apply resin all over the screed surface using a roller or notched spreader as a waterproofing layer of the resin flooring system.

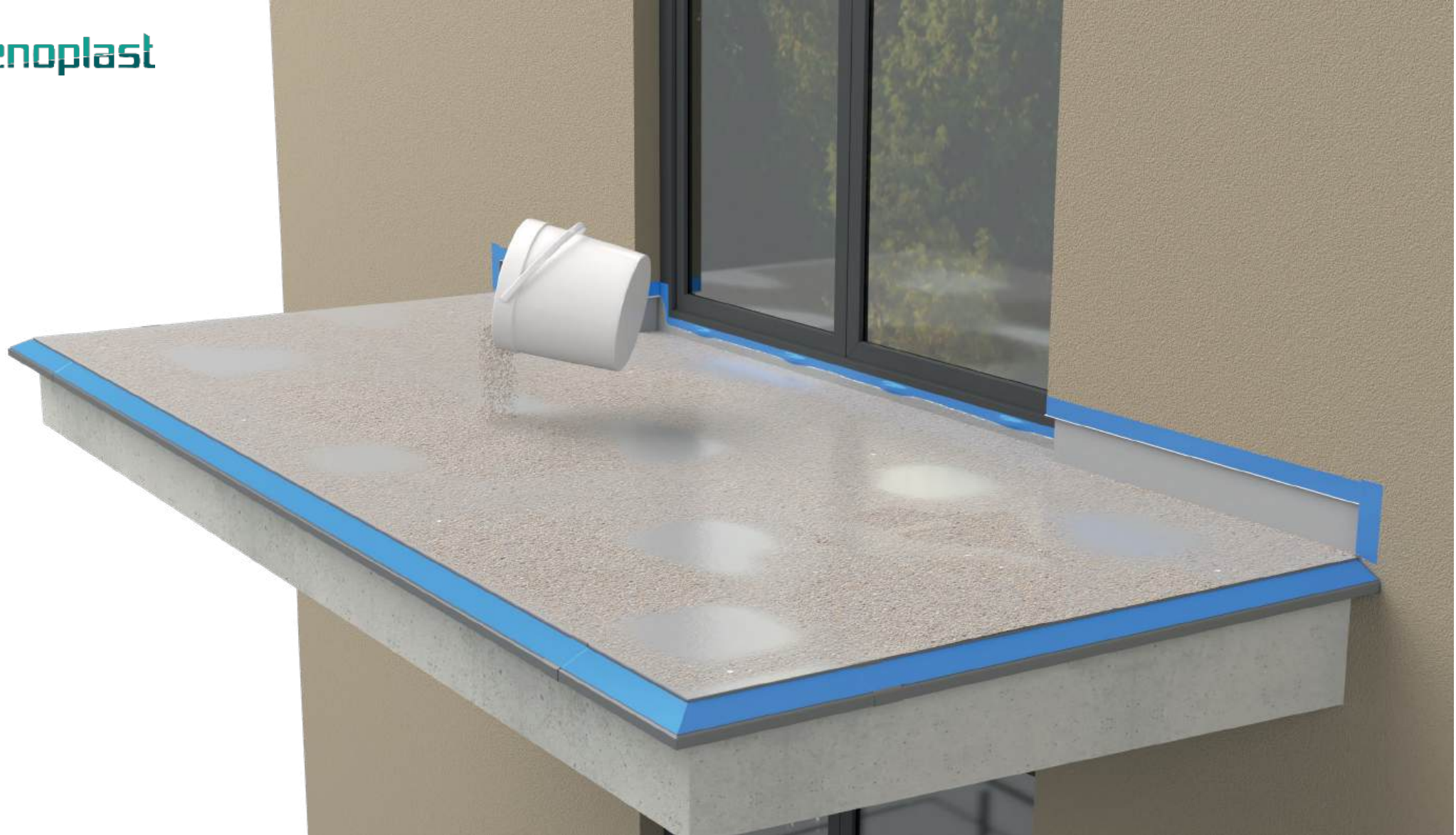

## **Sprinkling quartz sand to increase slip resistance**

Dry quartz sand is sprinkled on the resin layer when still fresh. Choose quartz sand of appropriate grading and permissible moisture content. Once the resin has cured, remove any excess sand.

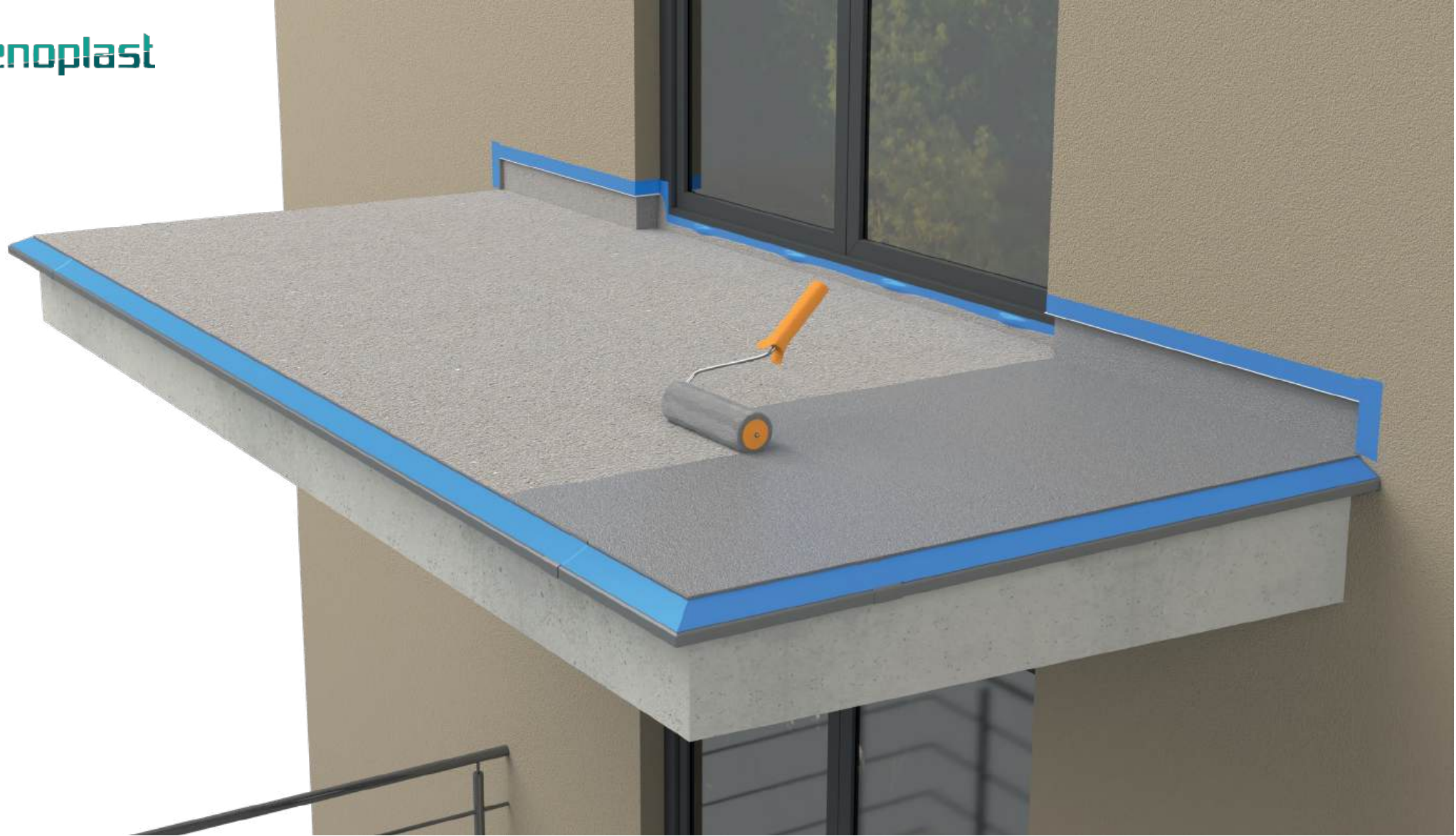

### **Topping the resin flooring system**

Finally, the topcoat resin should be applied all over the surface. The topcoat gives the floor colour and texture and may incorporate decorative flakes scattered onto the wet resin layer.

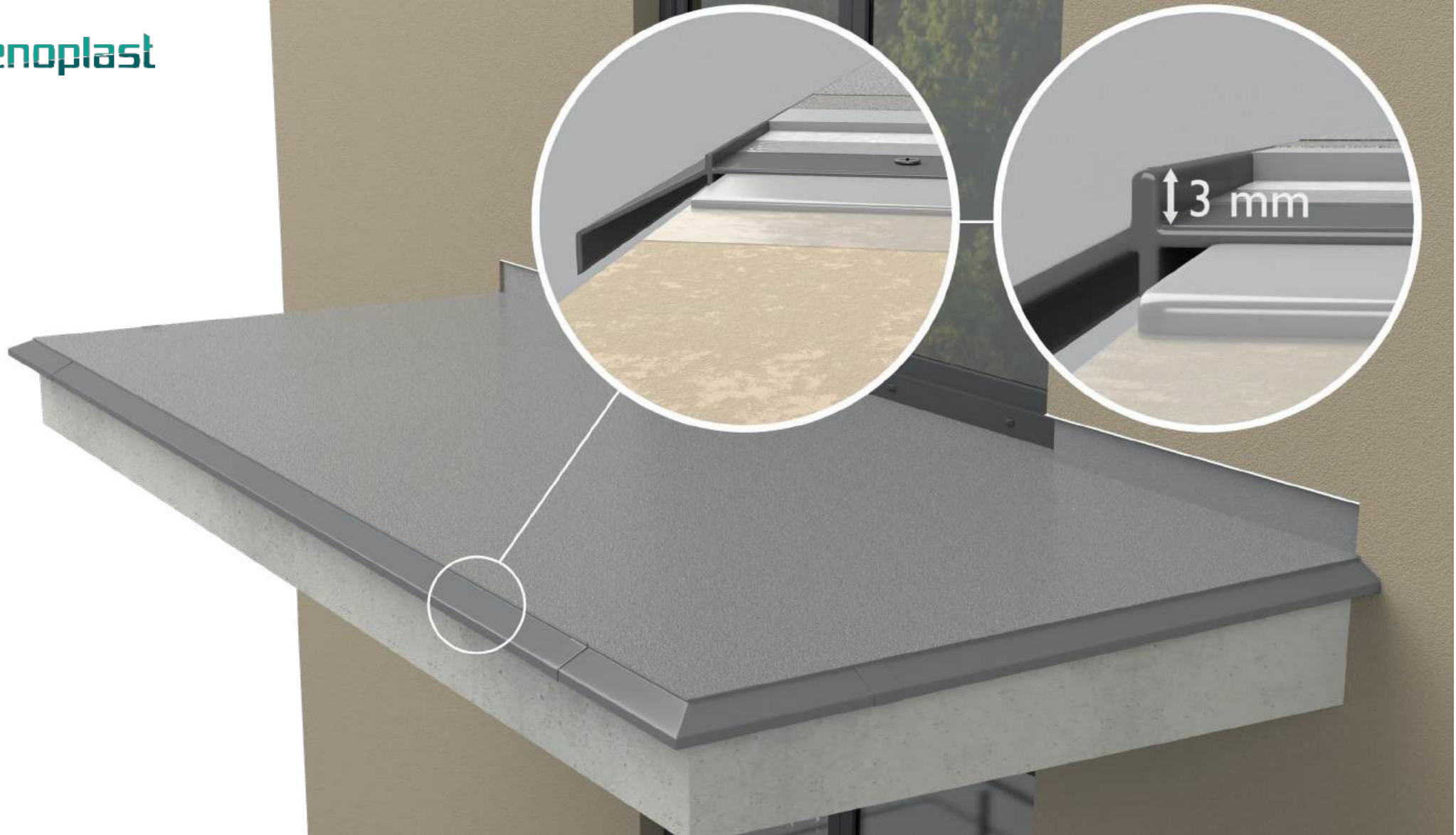

**NOTES:**

**K10** has a 3 mm high upstand along the front and side edges high to suit 2-4 mm thick resin flooring systems. This guide gives some general recommendations for three-layer resin flooring systems consisting of primer, waterproofing layer and topcoat. Since different systems are available in the market, always follow the manufacturer's guidelines.



**QUALICOAT**  
Inspired by architecture, trusted by professionals  
| SEASIDE |



**Renoplast**

[www.renoplast.pl/en](http://www.renoplast.pl/en)